



MecTronik s.r.l.

Via Dell'Artigianato, 5

37053 – Cerea (VR)

P.IVA e CF: 03266730237

Web: www.mectronik.com

Email: info@mectronik.com

Wiring Loom

ECU HW : MKE7_MT2

ECU FW : CEVMOTO2

P.N. : CBL0006

© 2022 - Mectronik srl

This quick reference document is drawn up with the aim to be simple and fast for user consultation and assist the user or technician in their work.

Mectronik is the supplier company of the wiring loom for the Moto2 class. and the target of this document is to help the technicians during the first installing, and as reference in case of electrical trouble. This mean also that the responsibility of the installation, the use and the damages about the not proper using is always to consider the user. This is a product design and built for the motorsport, without any homologation, warranty, certifications and so on. The company will be never responsibility for any type of the result, from technical and sporting point of view.

The layout of the wiring harness is design in agree to the championship organization, for to use in the kalex bikes equipped with 765 Triumph engines. All connectors provided for the engine components, require only OEM parts. The wiring harness branches length is designed for a flexible positioning that permit the use also in different bike frames.

The main wiring harness has many connections for a quick and easy connection of the optional parts like sensors, data acquisition devices and so on. The user can buy wiring adapters or build himself this parts, following all technical rules for a correct connections.

The installation of all parts in to the bike must be done only by a skilled technicians, with a proper tools in a safe condition.

No accessories for a correct mounting like tapes, cable ties, wrapper, thermal protections, screws, spacer and so on is supply with the KIT. Is always a responsibility of the installer to find in the market the correct accessories for a proper installation.

During the installation, check always the correct positioning of the wires, to avoid any interference with other parts, with excessive heating, or with moving parts. The wiring passages around the steering column must be done for avoiding any interference with the movements of the components involved.



THE KIT, THE ECU AND WIRING LOOM ARE FOR RACING USE ONLY. IT IS FORBIDDEN TO USE THE PRODUCTS IN THE PUBLIC ROADS. CONTACT YOUR LOCAL ESTABLISHMENT, FOR THE LEGAL RESTRICTIONS, AND THE USE LIMITATIONS.

**ALL RIGHTS RESERVED. NO PART OF THIS DOCUMENT CAN BE TRANSMITTED, IN ANY FORM, TO THIRD ENTITIES, WITHOUT PERMISSION FROM MECTRONIK S.R.L.
THE DATA ARE FREE TO CHANGE WITHOUT NOTICE.**

CONNECTORS IDENTIFICATION

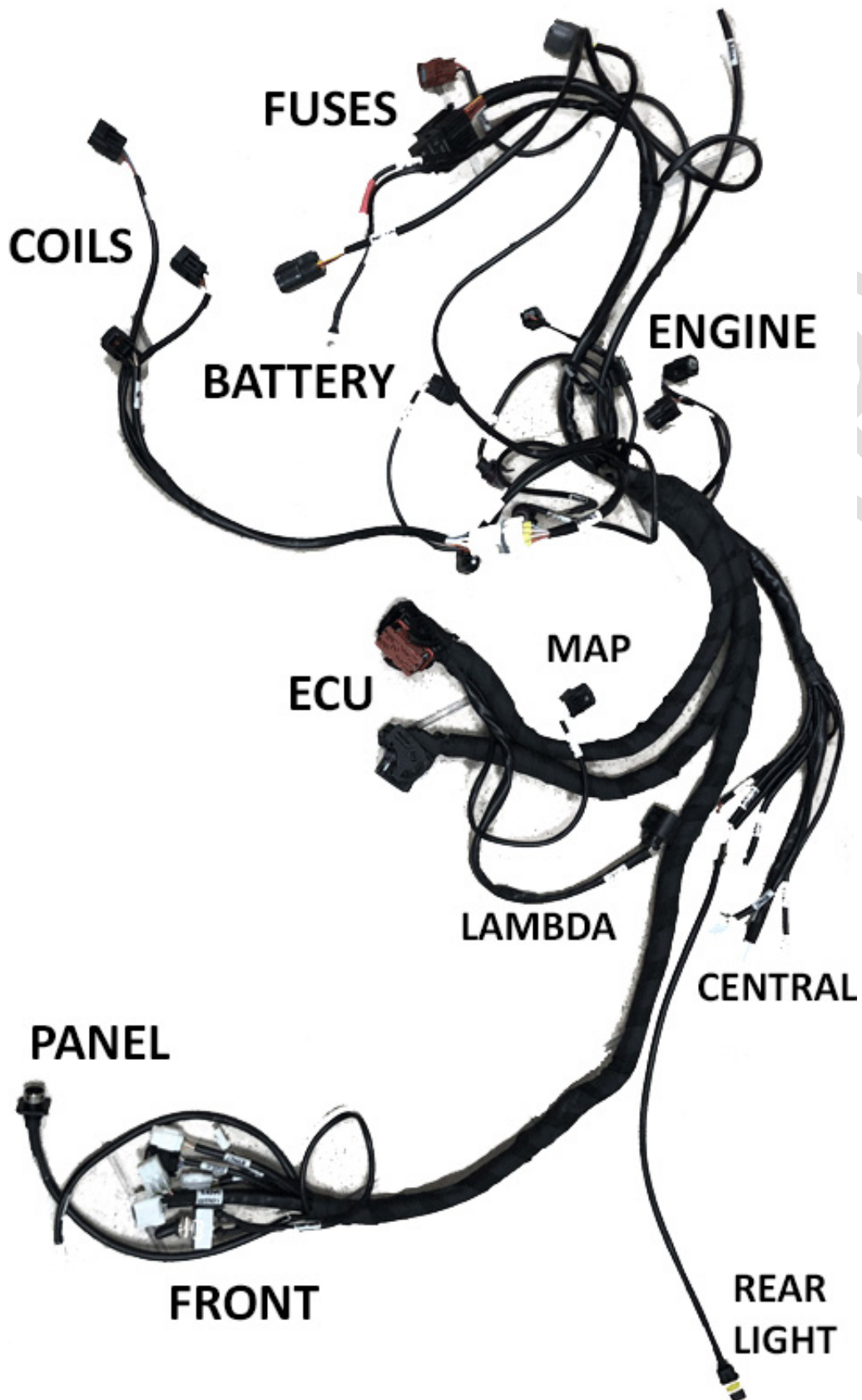

CONNECTORS – MAIN REFERENCE TABLE

REF.	LABEL	FUNCTION	POSITION	PINS
X3	REAR LIGHT	REAR RED LIGHT	REAR	2
X30	PICK-UP	CRANCKSHAFT SENSOR	CENTRAL	2
X39	COILS	COILS SUB HARNESS	ENGINE	6
X11	LOGGER-DASH	LOGGER SUB HARNESS	FRONT	6
X14	KILL SWITCH	HANDLEBAR ON-OFF SWITCH - RIGHT SIDE	FRONT	2
X32	WATER TEMP	ENGINE TEMPERATURE SENSOR	ENGINE	2
X33	GEAR POSITION	GEARBOX BARREL POSITION	CENTRAL	4
X27	GAS-GRIP	GRIP SENSOR OR GRIP ADAPTER	FRONT	6
X63	BARO	BAROMETRIC PRESSURE SENSOR	ON THE FRONT NOSE	3
X31	MAP CYL2	MANIFOLD PRESSURE OF CYLINDER 2	ECU 2 BRANCH	3
X36	OIL TEMP	OIL TEMPERATURE SENSOR	CENTRAL	2
X13	H.BAR LEFT SW	RIDER SELECTIONS SWITCHES	FRONT	2
X7	MAIN SPEED	FRONT SPEED- SENSOR 1	FRONT	3
X10	REAR SPEED	REAR SPEED SENSOR	CENTRAL	3
X47	REAR SUSP	REAR SUSPENSION SENSOR	CENTRAL	3
X48	FRONT SUSP	FRONT SUSPENSION SENSOR	FRONT	3
X6	BACKUP SPEED	FRONT SPEED- SENSOR 2 FOR BACKUP	FRONT	3
X35	QUICK SHIFT	GEARSHIFT SENSOR	CENTRAL	4
X19	LAMBDA	LAMBDA SENSOR	ECU 2 BRANCH	6
X34	OIL PRESS	OIL PRESSURE SENSOR	CENTRAL	3
X23	FUEL PRESS	FUEL PRESSURE SENSOR	NEAR TO INJ 3	3
X52	REAR BRAKE	REAR BRAKE PRESSURE SENSOR	CENTRAL	3
X53	FRONT BRAKE	FRONT BRAKE PRESSURE SENSOR	FRONT	3
X2		ECU 2	ON THE AIRBOX	48
X1		ECU 1	ON THE AIRBOX	32
X20	INJ 1	INJECTOR CYLINDER 1	ENGINE	2
X21	INJ 2	INJECTOR CYLINDER 2	ENGINE	2
X22	INJ 3	INJECTOR CYLINDER 3	ENGINE	2
X5	AIR TEMP	INTAKE AIR TEMPERATURE SENSOR	ON THE AIRBOX	2
X28	TPS	THROTTLE POSITION SENSOR	ENGINE	2
X29	DBW MOTOR	THROTTLE BODY MOTOR	ENGINE	6
X38	FUEL PUMP	FUEL PUMP - TANK	CENTRAL	2
X40	RECTIFIER	RECHARGE SYSTEM	LEFT SIDE	2
X37	CAN SPARE	AUXILIARY CONNECTION- X2 TRANSPONDER	CENTRAL	6
X16		MAIN STATIC RELAY	CENTRAL	
X12	PC LINK	CONNECTION TO PC	DASHBOARD PANEL	
SW1	MAIN ON/OFF	MAIN ON-OFF SWITCH	DASHBOARD PANEL	
X41	ENGINE GND	CONNECTION TO ENGINE CRANKCASE	CENTRAL	
X18	BAT +	BATTERY TERMINAL +	BATTERY	
X17	BAT -	BATTERY TERMINAL -	BATTERY	
F1	MINIFUSE 5A	DASHBOARD-ACQ-SPEED- POWER SUPPLY	CENTRAL	
F2	MINIFUSE 5A	LAMBDA PROBE - POWER SUPPLY	CENTRAL	
F3	MINIFUSE 30A	GENERAL POWER SUPPLY	CENTRAL	
F4	MINIFUSE 10A	ECU POWER SUPPLY	CENTRAL	

CONNECTORS PINOUT

ECU 2			
REF	PIN	NET	NOTE
X2	A1	FRONT_SPEED_1	
	A2	FRONT_SPEED2	
	A3	HANDLEBAR_L	
	A4	OIL P	
	B1		
	B2	BRAKE P FRONT	
	B3	BRAKE P REAR	
	B4	GAS POS1	
	C1	GAS POS2	
	C2	MAIN_RELAY	
	C3		
	C4		
	D1		
	D2	GND_SEN	
	D3	VKEY_ECU	
	D4		
	E1	GND_SEN	
	E2	GND_SCH	
	E3	VREF_GAS1	
	E4	VREF_AUX	
	F1	VREF_GAS2	
	F2		
	F3	CAN_H	
	F4	CAN_L	
	G1		
	G2		
	G3		
	G4		
	H1	RLIGHT	
	H2	VBAT_ECU	
	H3	GND	
	H4	GND	

ECU 1			
REF	PIN	NET	NOTE
X1	A1	CRANKSAFT+	
	A2	CRANKSHAFT-	
	A3	SPEED_REAR	
	A4	FUEL_P	
	B1	TPS1	
	B2	TPS2	
	B3	FORK POSITION	
	B4	QUICK_SHIFT	
	C1	UN_LSU	
	C2	AIRBOX_P	
	C3	MANIFOLD_P	
	C4	SHOCK POSITION	
	D1	WATER_T	
	D2	AIR_T	
	D3	OIL_T	
	D4	GEAR_POSITION	
	E1		
	E2	VM_LSU	
	E3	IA_LSU	
	E4	IP_LSU	
	F1		
	F2		
	F3		
	G1	INJ1_DN	
	G2	INJ2_DN	
	G3	INJ3_DN	
	G4		
	H1		
	H2		
	H3	HTR-_LSU	
	H4	GND_SEN	
	J1	GND_SEN	
	J2	GND_SEN	
	J3	GND_SEN	
	J4	GND_SCH	
	K1	VREF	
	K2	VREF	
	K3	VREF_AUX	
	K4	VREF_AUX	
	L1		
	L2	THROTTLE M+	
	L3	COIL1	
	L4	COIL2	
	M1		
M2	THROTTLE M-		
M3			
M4	COIL3		

R.LIGHT			
REF	PIN	NET	NOTE
X3	1	RLIGHT	
	2	GND	

The Mating Part is : TYCO Super Seal PN: 282104-1

AIR TEMP			
REF	PIN	NET	NOTE
X5	1	AIR_T	
	2	GND_SEN	

BACKUP SPEED			
REF	PIN	NET	NOTE
X6	1	GND	
	3	KEY_FUSE	
	2	FRONT_SPEED2	

The Mating Part is : 03T-JWPF-VSLE-S

The PIN number is marked on the part

MAIN SPEED			
REF	PIN	NET	NOTE
X7	1	GND	
	3	KEY_FUSE	
	2	FRONT_SPEED1	

The Mating Part is : 03T-JWPF-VSLE-S

The PIN number is marked on the part

REAR SPEED			
REF	PIN	NET	NOTE
X10	1	GND	
	3	KEY_FUSE	
	2	REAR_SPEED	

The Mating Part is : 03T-JWPF-VSLE-S

The PIN number is marked on the part

LOGGER-DASH			
REF	PIN	NET	NOTE
X11	1	GND	
	2	CAN_L	
	3	CAN2D_L	
	4	KEY_FUSE	
	5	CAN_H	
	6	CAN2D_H	

PC LINK			
REF	PIN	NET	NOTE
X12	1	GND	
	2	CAN_L	
	3	CAN_H	

The Mating Part is : UTG6103PN

The PIN number is marked on the part

H.BAR LEFT SW			
REF	PIN	NET	NOTE
X13	1	HANDLEBAR_L	
	2	GND_SEN	

KILL SWITCH			
REF	PIN	NET	NOTE
X14	1	VKEY_ECU	
	2	VKEY	

FUEL PUMP RELAY			
REF	PIN	NET	NOTE
X16	1	VBAT_FUSE	
	2	VKEY_ECU	
	3	VPOWER	
	4	MAIN_RELAY	



The FUEL RELAY part, feed also the engine actuators such injectors and ignition. Is a SOLID STATE components, not a standard type with a built in current limiting (like a electronic fuse). If you need to replace the part, contact Mectronik for a correct spare part.

BAT -			
REF	PIN	NET	NOTE
X17	1	GND	

BAT +			
REF	PIN	NET	NOTE
X18	1	VBAT	

LAMBDA			
REF	PIN	NET	NOTE
X19	1	IP_LSU	
	2	VM_LSU	
	5	IA_LSU	
	6	UN_LSU	
	3	HTR-_LSU	
	4	HTR+_LSU	

INJ CYL1			
REF	PIN	NET	NOTE
X20	1	INJ1_DN	
	2	VPOWER	

INJ CYL2			
REF	PIN	NET	NOTE
X21	1	INJ2_DN	
	2	VPOWER	

INJ CYL3			
REF	PIN	NET	NOTE
X22	1	INJ3_DN	
	2	VPOWER	

FUEL PRESS			
REF	PIN	NET	NOTE
X23	A	GND_SEN	
	B	VREF_AUX	
	C	FUEL_P	

COIL 1			
REF	PIN	NET	NOTE
X24	1	VPOWER_A	
	2	COIL1_A	

COIL 2			
REF	PIN	NET	NOTE
X25	1	VPOWER_A	
	2	COIL2_A	

COIL 3			
REF	PIN	NET	NOTE
X26	1	VPOWER_A	
	2	COIL3_A	

GAS			
REF	PIN	NET	NOTE
X27	1	GND_SEN	
	5	VREF_GAS1	
	3	GAS POS1	
	4	GAS POS2	
	2	VREF_GAS2	
	6	GND_SEN	

TPS			
REF	PIN	NET	NOTE
X28	2	GND_SEN	
	5	VREF	
	4	TPS1	
	3	TPS2	
	6		
	1		

DBW MOTOR			
REF	PIN	NET	NOTE
X29	1	THROTTLE M+	
	2	THROTTLE M-	

PICKUP			
REF	PIN	NET	NOTE
X30	1	CRANKSHAFT-	
	2	CRANKSAFT+	

MAP CYL2			
REF	PIN	NET	NOTE
X31	1	VREF	
	2	MANIFOLD_P	
	3	GND_SEN	



The Ecu use the MAP signal for engine synchronization also. The rubber pipe of the sensor must be proper connected only to the CYL 2 . The OEM pipes need to be modify . Please to see the dedicated note regarding this topic.

WATER TEMP			
REF	PIN	NET	NOTE
X32	1	GND_SEN	
	2	WATER_T	

GEAR POSITION			
REF	PIN	NET	NOTE
X33	2	GEAR_POSITION	
	3	GND_SEN	
	4	VREF_AUX	
	1		

OIL PRESS			
REF	PIN	NET	NOTE
X34	A	GND_SEN	
	B	VREF_AUX	
	C	OIL P	

QUICK SHIFT			
REF	PIN	NET	NOTE
X35	1	GND_SEN	
	2	QUICK_SHIFT	
	3	VREF_AUX	
	4	KEY_FUSE	

OIL TEMP			
REF	PIN	NET	NOTE
X36	1	GND_SEN	
	2	OIL_T	

The Mating Part is : 02T-JWPF-VSLE-S

The PIN number is marked on the part

CAN SPARE			
REF	PIN	NET	NOTE
X37	1	GND	
	2	CAN_L	
	3	CAN2D_L	
	4	KEY_FUSE	
	5	CAN_H	
	6	CAN2D_H	

The Mating Part is : 06T-JWPF-VSLE-S

The PIN number is marked on the part

FUEL PUMP			
REF	PIN	NET	NOTE
X38	1	GND	
	2	VPOWER	

COILS			
REF	PIN	NET	NOTE
X39	1	COIL1	
	2	COIL2	
	3	COIL3	
	4	VPOWER	
	5	VPOWER	
	6	VPOWER	



For the connection to the coils, is supply with the main harness, a proper sub harness. The cylinder numbers 1-2-3 is intended from left to the right side.

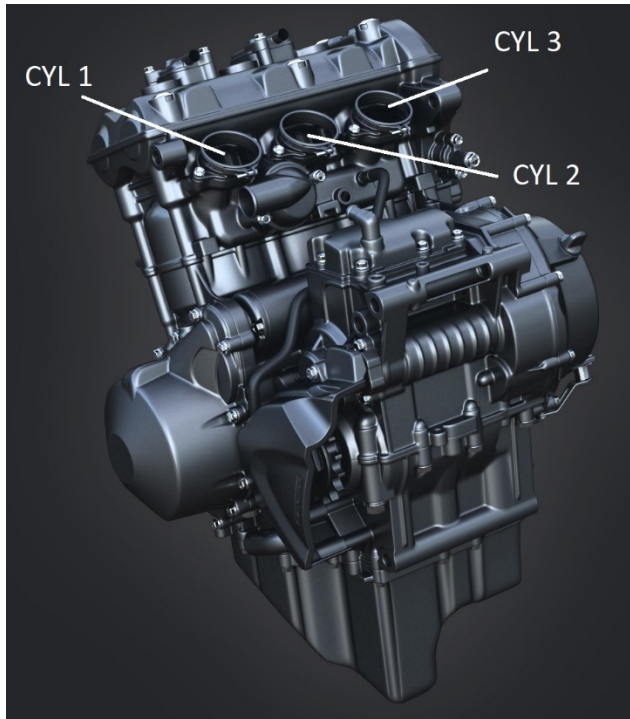

RECTIFIER			
REF	PIN	NET	NOTE
X40	1	VBAT_FUSE	
	2	GND	

ENGINE GND			
REF	PIN	NET	NOTE
X41	1	GND	



THE MAIN GND CONNECTION MUST BE FIXED TO A ENGINE CRANKCASE SCREW, CLEANED NOT PAINTED AND WITH A GOOD SURFACE FOR A MINIMUM ELECTRIC RESISTANCE. A NOT RESPECT TO THIS RULES CAN DAMAGE THE ECU AND ALL ELECTRONIC DEVICES OF THE BIKE.

REAR SUSP			
REF	PIN	NET	NOTE
X47	1	GND_SEN	
	2	VREF_AUX	
	3	SHOCK POSITION	

The Mating Part is : 03T-JWPF-VSLE-S

The PIN number is marked on the part

FRONT SUSP			
REF	PIN	NET	NOTE
X48	1	GND_SEN	
	2	VREF_AUX	
	3	FORK POSITION	

The Mating Part is : 03T-JWPF-VSLE-S

The PIN number is marked on the part

REAR BRAKE			
REF	PIN	NET	NOTE
X52	1	GND_SEN	
	2	VREF_AUX	
	3	BRAKE P REAR	

FRONT BRAKE			
REF	PIN	NET	NOTE
X53	1	GND_SEN	
	2	VREF_AUX	
	3	BRAKE P FRONT	

BARO			
REF	PIN	NET	NOTE
X63	1	VREF	
	2	AIRBOX_P	
	3	GND_SEN	



THE BARO SENSOR IS THE SAME PART USED FOR MAP. MUST BE BOUGHT LIKE A TRIUMPH SPARE PART OVER THE OFFICIAL DEALERS NETWORK. THE POSITIONING IS TO MADE ON THE AIR NOSE IN THE FRONT OF THE BIKE. SEE THE PICTURES BELOW

FUSES

There are 4 fuses for a safety protection in case of electrical failures. The power lines are joint for a functionality logic, for avoid to kill the engine in case of electrical failures of a optional functionality.

FUSE REF	TYPE	CIRCUIT FEED
F1	MINIFUSE 5A	DataLogger, Dashboard, Quickshifter, Transponder, Speed Sensors
F2	MINIFUSE 5A	Lambda Probe
F3	MINIFUSE 30A	Battery Line, All circuits
F4	MINIFUSE 10A	Ecu Power supply

PRELIMINARY

MAP SENSOR

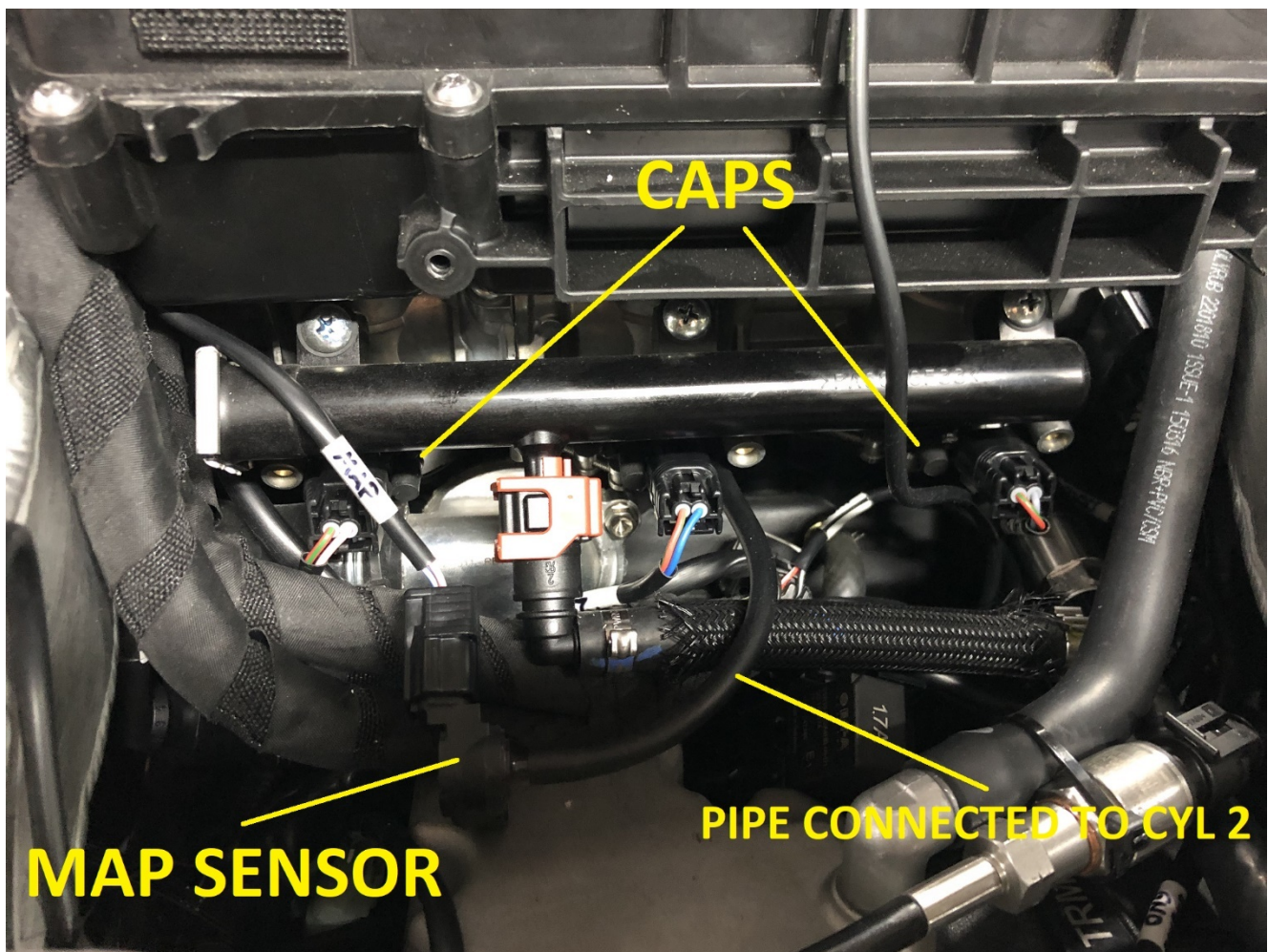

 The rubber pipe must be keep more short of possible



LAMBDA SENSOR

The Ecu can manage a Wide Band Lambda Sensor, to read and control the A/F Ratio. Refer to the specific document available about the Injection setting for more info. In the exhaust pipe recommended by Triumph, there is a predisposed hole for a lambda sensor. Check always that the system must be properly sealed. A unwanted air or unburned mixture can modify the real A/F ratio of the engine.



Only the correct BOSCH LSU 4.9 sensor must be connected to the Lambda Connector. Every other Sensor, it is forbidden and can damage the ECU.

Lambda Sensor Spare Parts: MECTRONIK SEN_LU49



SPEED SENSORS

The wiring loom provided is designed for the connection up to 3 speed sensors. Two for the front wheel speed measure (one main and other one such a backup signal), and one for the rear wheel speed measure. The mounting of the sensors and its trigger wheel is responsibility of the installer. Refer to the speed sensor datasheet about the technical solution to be adopted, its gap and trigger wheel shapes. Keep in mind that the speed signals sent to the ecu must be a square wave type, 0-5V with 50 % of duty cycle, and with a maximum frequency of 2.5Khz. A original Kalex trigger wheel is suggested. No other moving metal components like screws, bolts parts must be within the surrounding area of sensor. The stiffness of the sensor mounting and its brackets must avoid any vibrations during the functionality.

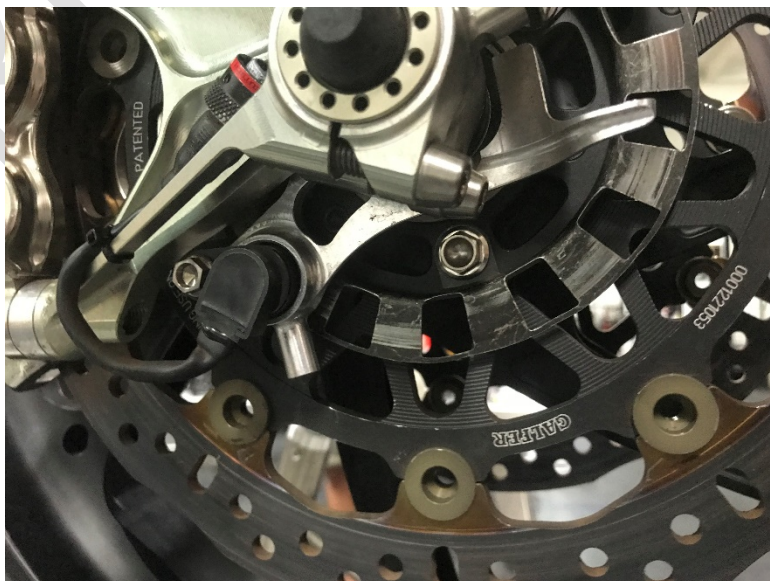
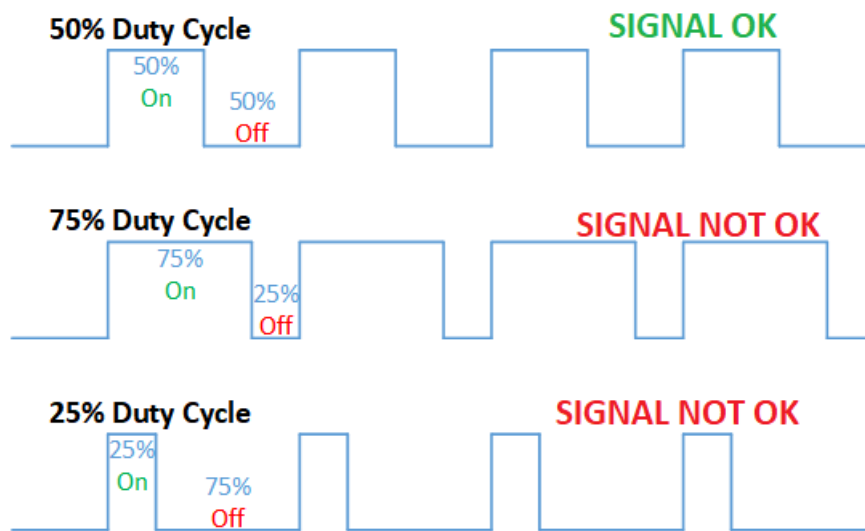

WIRING HARNESS MOUNTING

Below, some photo about how the wiring harness should be fitted to the bike. Are to use like a reference only. Please to read the general information reported at Pag 2 .



The ecu must be isolated by the engine and bike vibrations. A proper support should be adopted like as supply by Mectronik, built with a silicone enclosure and aluminum bracket. The installer should check always that none interferences between ecu assembly and other components like airbox, screws, covers and so on.





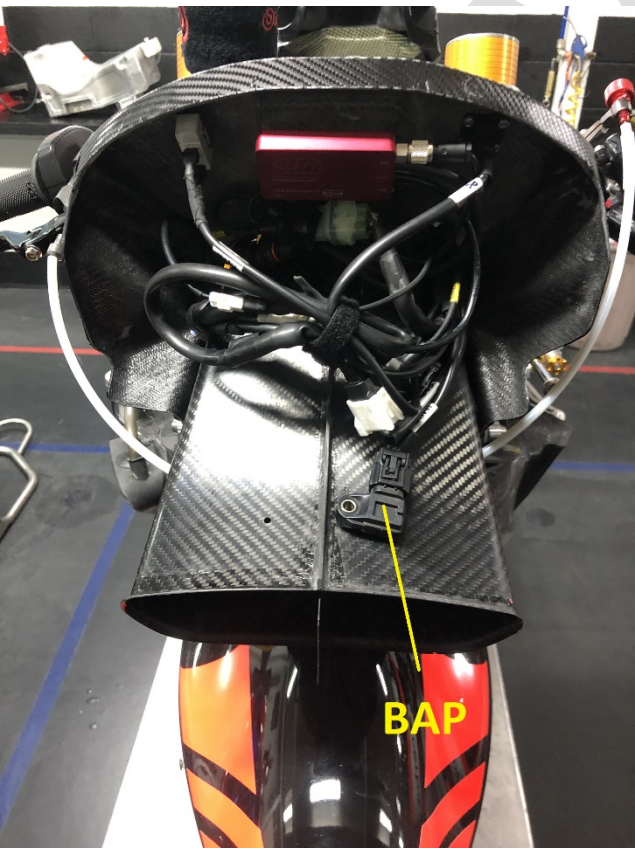
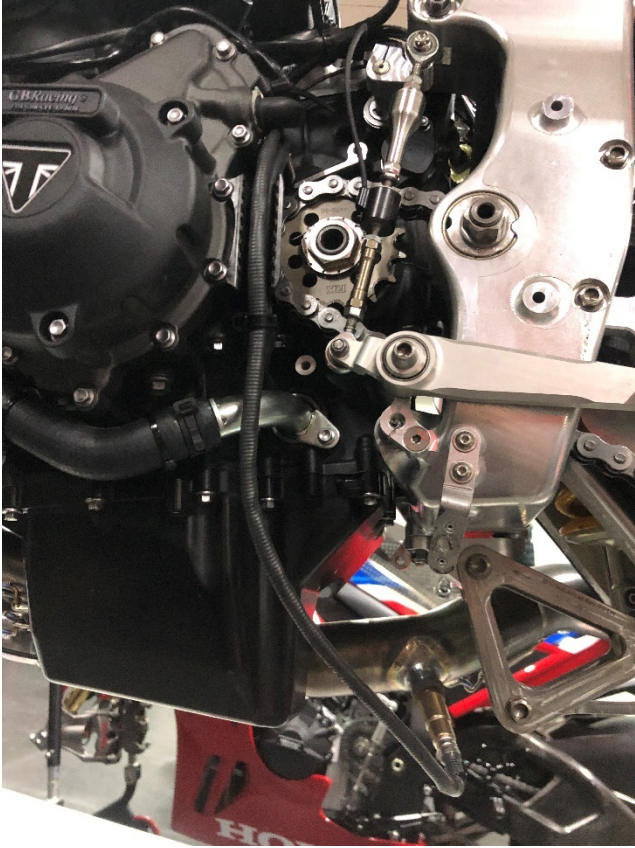

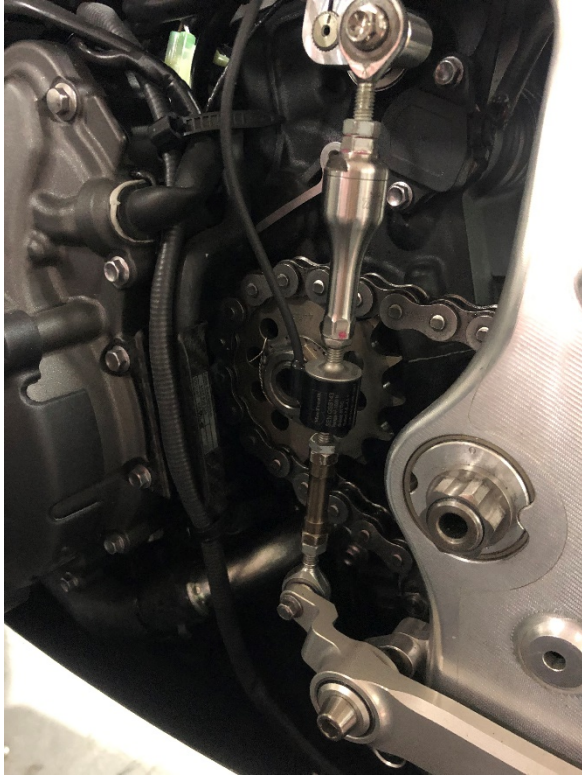

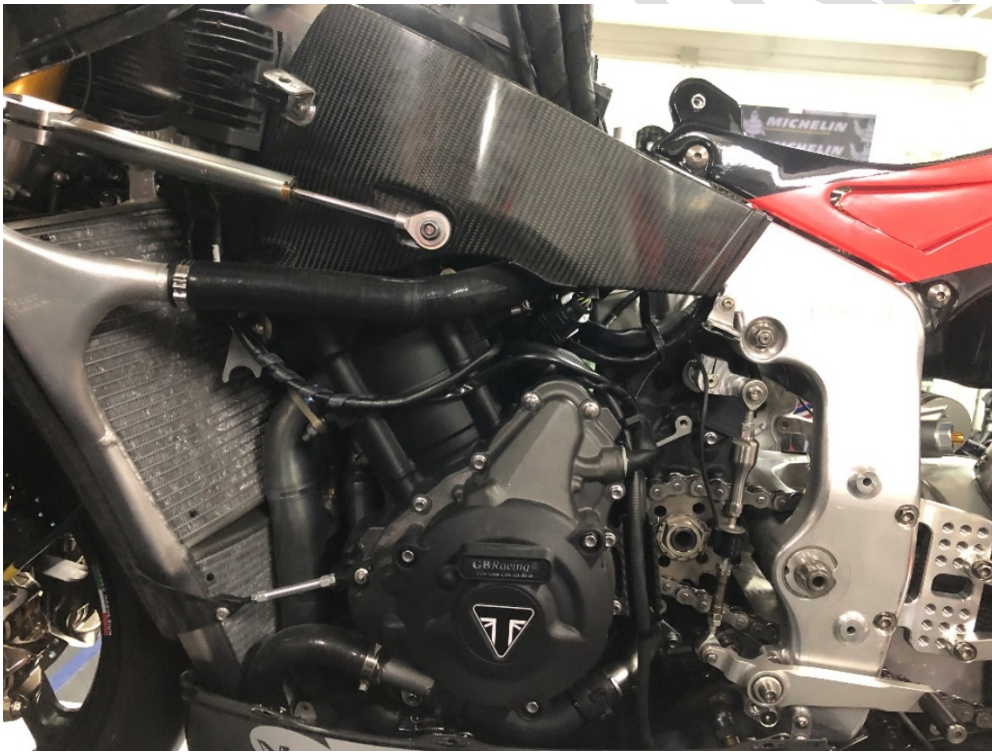
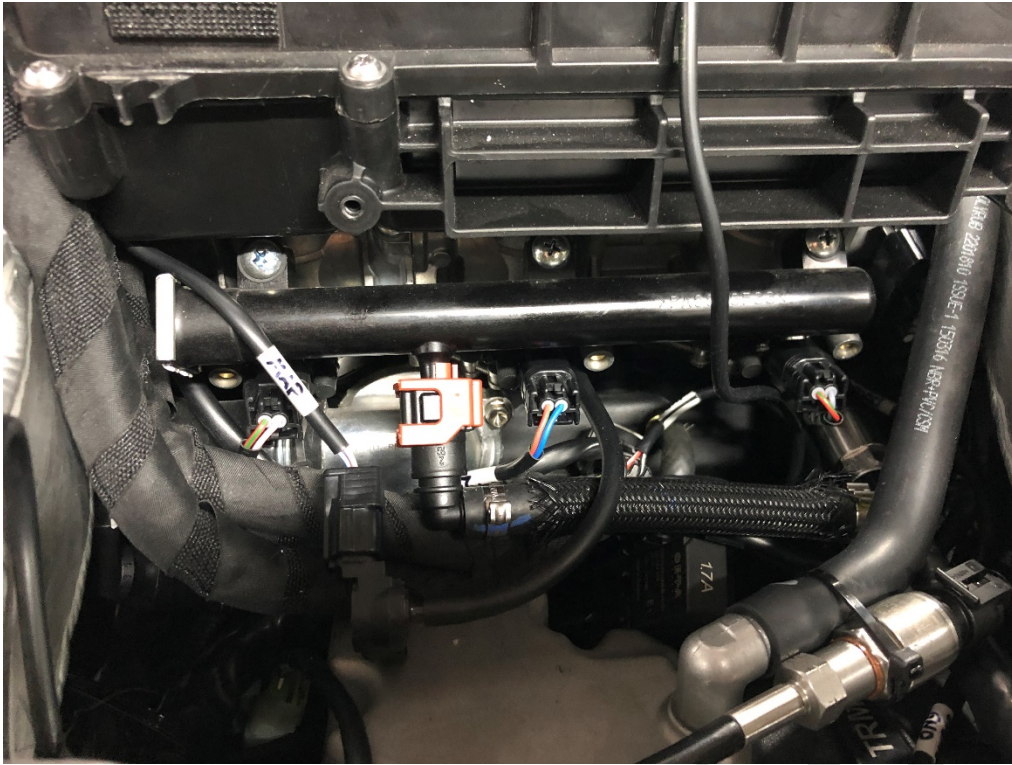



PRELIMINARY